



# User's Manual

Docking Station

**TS-DPD6N**

2024/05

(v1.7)



# Table of Contents

1. Introduction .....	2
<b>1-1 Docking Station Overview</b> .....	2
<b>1-2 Package Content</b> .....	4
2. Installation Guide .....	5
<b>2-1 Getting Started</b> .....	5
<b>2-2 Administrative Setup</b> .....	8
<b>2-3 Reset Device</b> .....	11
<b>2-4 Firmware Update</b> .....	11
3. Specifications .....	13
4. Frequently Asked Questions .....	14
5. Recycling and Environmental Protection .....	15
6. Warranty Policy.....	15
7. GNU General Public License (GPL) Disclosure .....	15
8. End-User License Agreement (EULA) .....	15
9. Federal Communications Commission (FCC) Statement.....	16
10.    EU Compliance Statement .....	16
11.    Eurasian Conformity Mark (EAC) .....	16

# 1. Introduction

## 1-1 Docking Station Overview

Transcend's DPD6N networked docking station is designed specifically for the DrivePro Body 30/60/70 and offers a complete charging, data upload, and camera management solution. Users are allowed to effortlessly charge multiple DrivePro Body 30/60/70 devices at one go, while files (including video recordings and snapshots) may also be shared to an external storage device via a USB port.

To provide scalability and fast deployment, the docking station is equipped with two Ethernet ports, including a LAN port and a WAN port, as well as one USB 3.0 port, which is backwards compatible with USB 2.0. All ports are located on the right side of the docking station. The LAN port is for administrative setup specifically, using a fixed IP address to ensure that the settings are not at the risk of hackers or invasions from external networks. The WAN port, on the other hand, is for data backup to a designated folder while charging.

### NOTE

- The USB port can only be connected to an external device, and not to personal computers.
- For the best security of your data, the WAN port IP, which can be modified, ought not to share the same domain with the LAN port IP, which cannot be modified.
- For online data backup, you need to prepare two computers. One computer is for administrator setup by connecting it to the LAN port; the other computer is for online data backup by connecting it to the WAN port.

### Top View

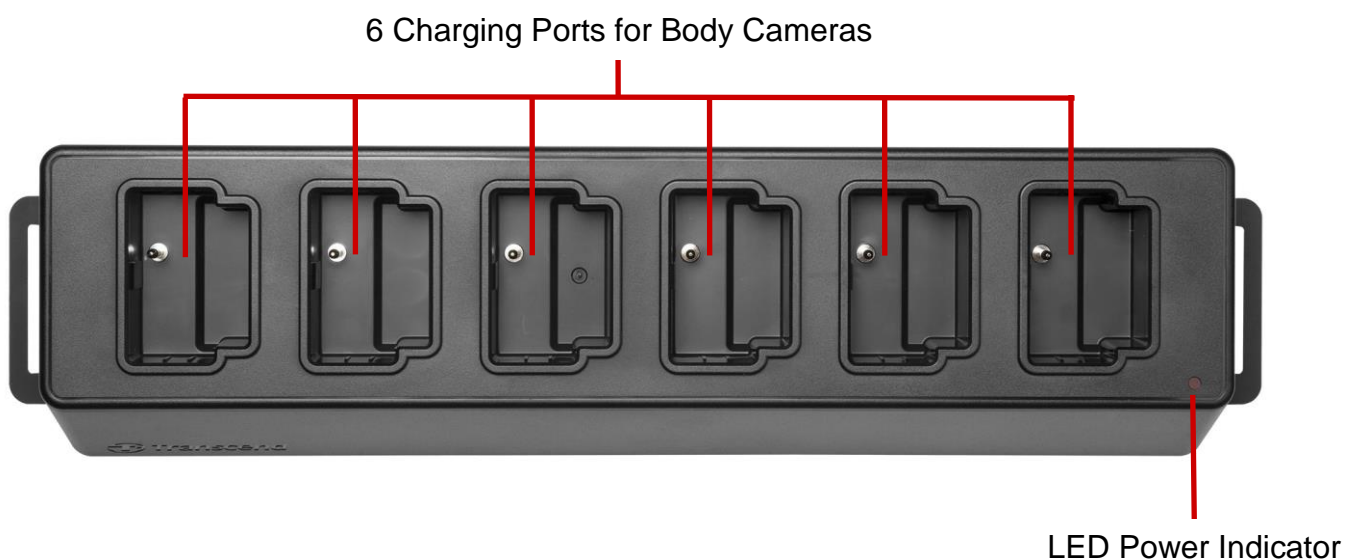

## Back View



## Functions & Description

- Six charging ports:
  - ✓ The six ports allow for up to six DrivePro Body cameras to charge and upload at the same time. When the body camera is transferring data, the LED indicator on the body camera will flash green.
- LED Power Indicator:
  - ✓ When connected to a power supply source, turn the Power Switch on. The LED Power Indicator will begin by first slowly flashing red, before turning solid red when the connection is finished.

## Right Side View

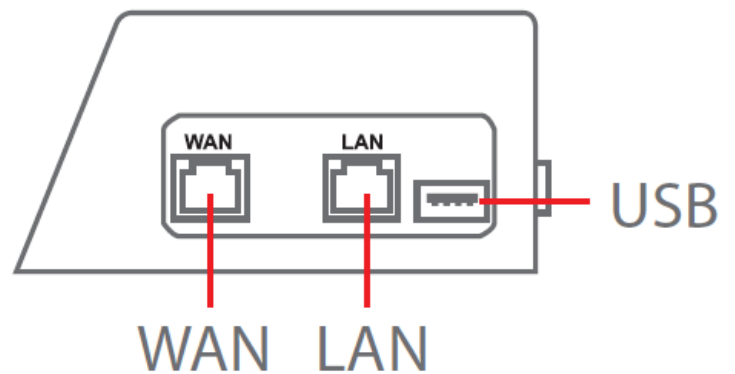

## Functions & Description

- LAN port:
  - ✓ For administrative setup
  - ✓ Fixed IP address
- WAN port:
  - ✓ For data transmission (via local network connection)
  - ✓ IP can be modified by administrator
- USB 3.0 port:
  - ✓ For exporting data to an external storage device (USB flash drives, external drives, etc.)
  - ✓ Backwards compatible with USB 2.0

## 1-2 Package Content

Your DPD6N package comes with the following contents:



Six-port docking station



Ethernet cables (2 pcs)



Power adapter

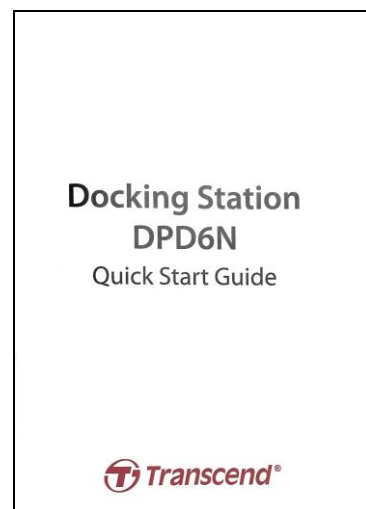

**Docking Station  
DPD6N**  
Quick Start Guide



Quick Start Guide

## 2. Installation Guide

### 2-1 Getting Started

When installing your DPD6N for the first time, please follow the steps below:

1. Plug in the power adapter and turn the power switch on.

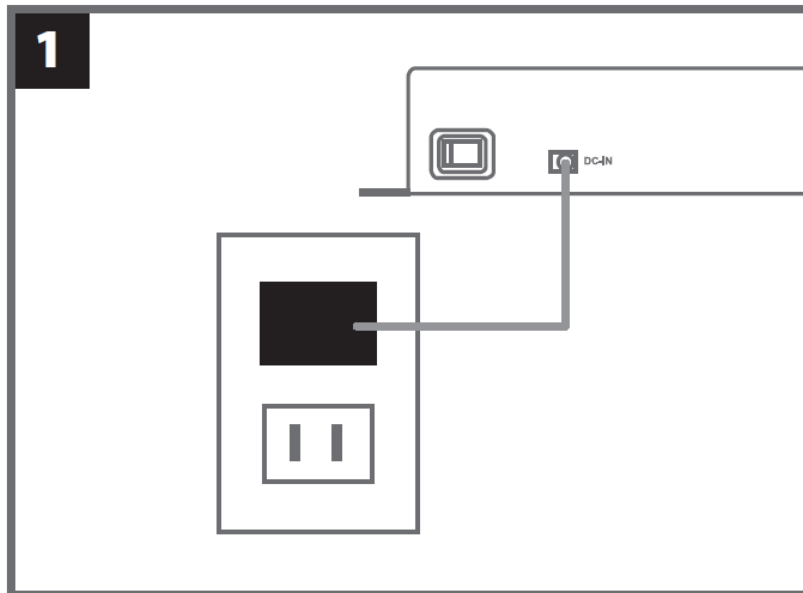

2. Use one Ethernet cable to connect the LAN port and the Internet port of the administrator's computer.

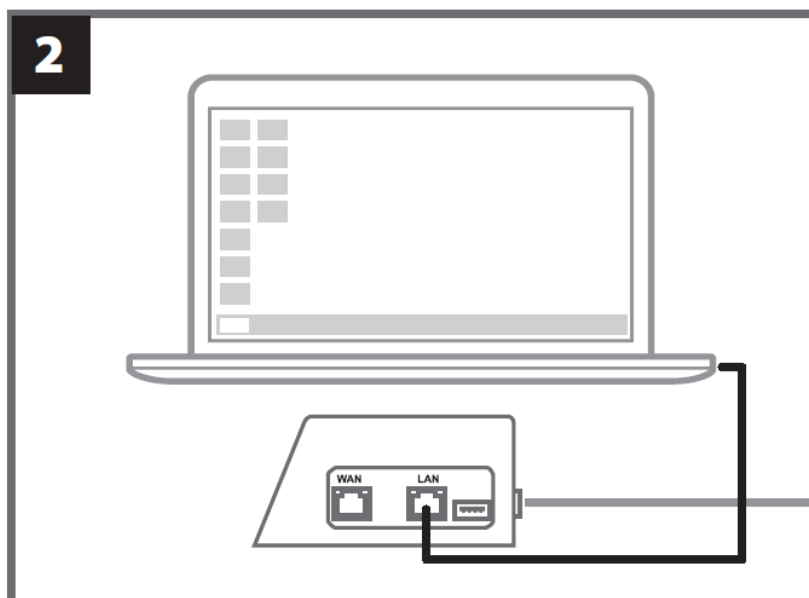

3. Use the other Ethernet cable to connect the WAN port and an active Internet port or a port of a Local Area Network.



4. Be sure to have **both** the LAN port and the WAN port connected to their respective internet ports, before proceeding to the next step. If either one of the two cables is not plugged in, or is plugged in the incorrect ports, auto backup setup will fail.

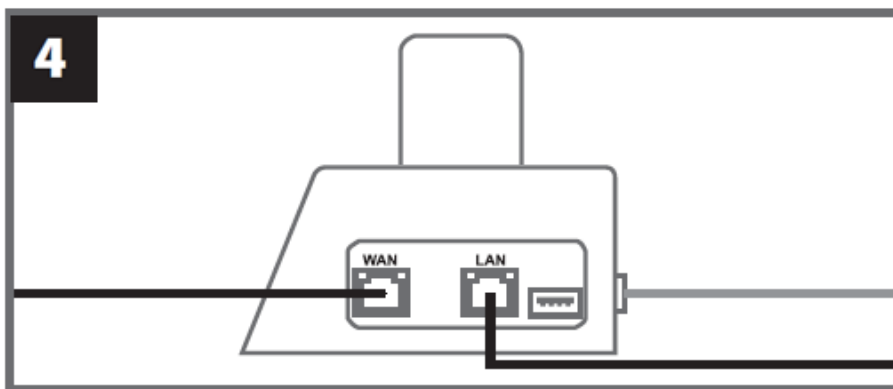

5. Change the IP address of the administrator's computer to 10.10.0.100.

#### NOTE

If the DPD6N is installed with the version 1.9 or later firmware, the computer will automatically obtain the IP address. This step can be omitted.

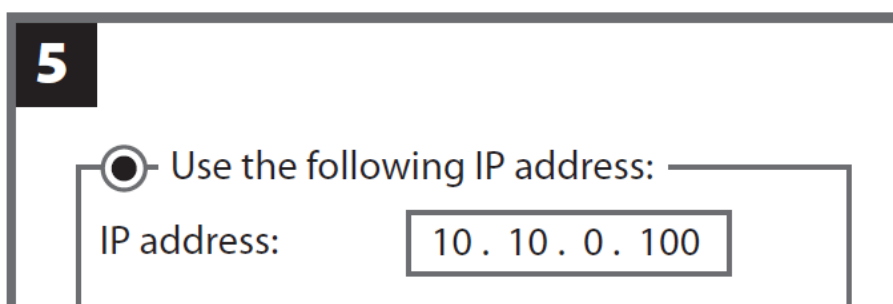

6. Open the browser and link to <http://10.10.0.1> on the administrator's computer.

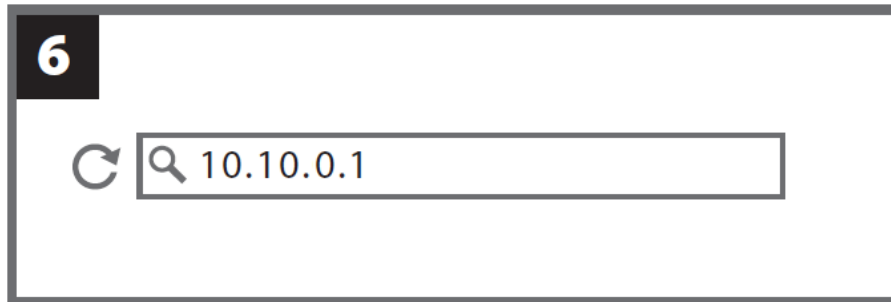

A screenshot of a browser's address bar. On the left, there is a black square containing the white number '6'. To the right of this square is a circular refresh icon. Further right is a search icon (magnifying glass) followed by the text '10.10.0.1' inside a rectangular input field.

7. Enter the default user name "admin" and password "12345678" to log in.

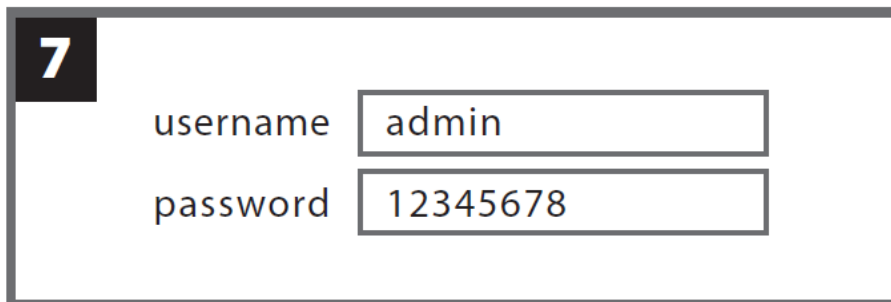

A screenshot of a login form. On the left, there is a black square containing the white number '7'. To the right of this square are two rows of labels and input fields. The first row has the label 'username' followed by an input field containing the text 'admin'. The second row has the label 'password' followed by an input field containing the text '12345678'.



## 2-2 Administrative Setup

After logging in as administrator, complete the instructions on the web page:

The screenshot shows the administrative web interface for a Transcend DrivePro™ Body. The header includes the Transcend logo and the product name, along with an 'admin' link. The main content area is divided into three sections:

- Language:** A gear icon followed by the text 'Language' and a dropdown menu currently set to 'English'.
- Firmware Version:** An information icon followed by the text 'Firmware Version' and the value 'v1.17.0'.
- Auto back up:** A folder icon followed by the text 'Auto back up' and a toggle switch currently set to 'ON'. Below this are three radio button options:
  - USB Storage:** Selected with a blue dot.
  - Network:** Unselected.
  - FTP:** Unselected.Each unselected option has a corresponding 'Save' button and input fields for 'Folder location', 'Username', and 'Password'. The 'Network' option also has a 'Save' button. At the bottom of this section, there is a checkbox for 'Delete files after backup is completed' and a section for 'Backup Folder Naming Methods' with radio buttons for 'UID' (selected) and 'User label'.

1. In **Language**, select your language.
2. In **Firmware Version**, check the current firmware version of DPD6N
3. In **Auto backup**, choose your desired backup method and destination. Select “USB Storage” to back up data to external storage space. Select “Network” or “FTP” to back up data to a local network location. Entering folder location and user ID is required.

### NOTE

Before backing up data over the Internet, please make sure you set the designated folder to “share this folder” and allow storage access to this folder.

4. In **Backup Folder Naming Methods**, choose “UID” or “User label”. UID is not modifiable. To change User Label, please connect your body cameras to a computer using a 3.5mm to USB cable and modify the user label from the DrivePro Body Toolbox.

If you encounter problems while installing the DPD6N, please check Transcend’s FAQ page at: <https://www.transcend-info.com/Support/No-786>

The screenshot displays a settings menu with three main sections, each separated by a horizontal line:

- Auto Unlock:** Features a toggle switch labeled "ON" (with a blue indicator). Below it are two sections:
  - Default password:** A text input field containing "Password" and a "Save" button.
  - Individual Password:** A dropdown menu currently showing "UID", a text input field containing "Password", and a "Save" button.
- Change Login Password:** Contains three stacked text input fields labeled "Original Password", "New Password", and "Confirm Password", followed by a "Save" button.
- Change IP address:** Features a toggle switch labeled "OFF". Below it are three stacked text input fields labeled "IP address", "Subnet mask", and "Default gateway", followed by a "Save" button.

5. If your DrivePro Body 30/60/70 is password protected, in **Auto Unlock**, you may set the password for the DPD6N to automatically unlock the body camera.
6. In **Change login password**, you may change the default login password “12345678” to new passwords.

**NOTE**

- We recommend changing the password the first time you log in.
- The default user name “admin” is not modifiable.

7. Modify the WAN IP address in **Change IP address** to back up data to your desired external IP address.

#### NOTE

This option is for changing the WAN IP only. The LAN IP should still be 10.10.0.100, and, if must be altered, must not share the same network domain with the WAN IP address for the best security of your data.

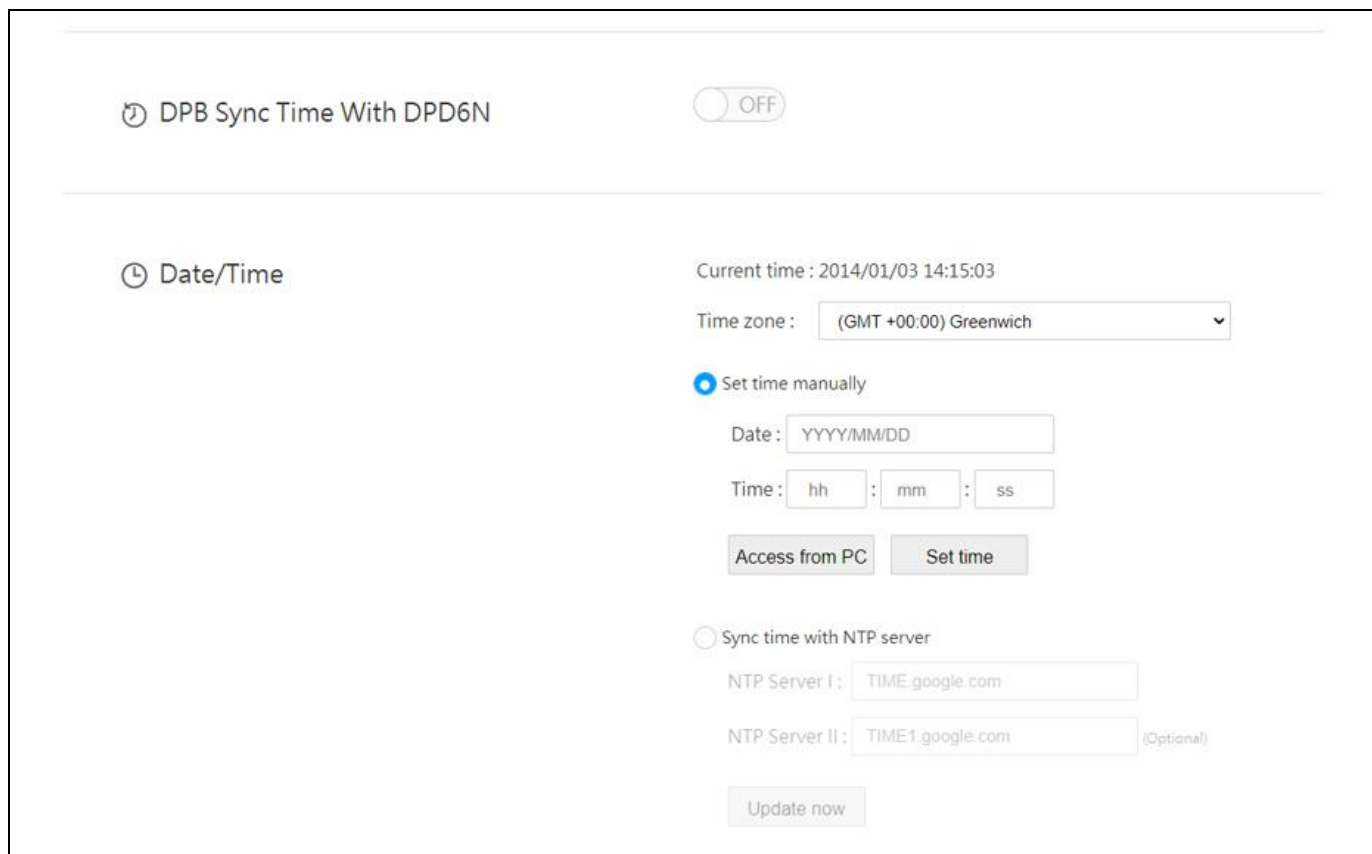

DPB Sync Time With DPD6N  OFF

Date/Time

Current time : 2014/01/03 14:15:03

Time zone : (GMT +00:00) Greenwich

Set time manually

Date : YYYY/MM/DD

Time : hh : mm : ss

Access from PC Set time

Sync time with NTP server

NTP Server I : TIME.google.com

NTP Server II : TIME1.google.com (Optional)

Update now

8. In **DPB Sync Time with DPD6N**, choose whether the time of DrivePro Body 30/60/70 should be synchronized with the DPD6N.
9. In **Date/Time**, you can synchronize the time on the computer or NTP server with the DPD6N to ensure the date and time are correct.
10. Setup is complete. Start charging the DrivePro Body and backing up data simultaneously.

#### NOTE

If the setting is completed, you can remove the LAN cable from DPD6N.

## 2-3 Reset Device

To reset the DPD6N or when the login password is forgotten, click on “Forgot Password?”. All the settings will be deleted.

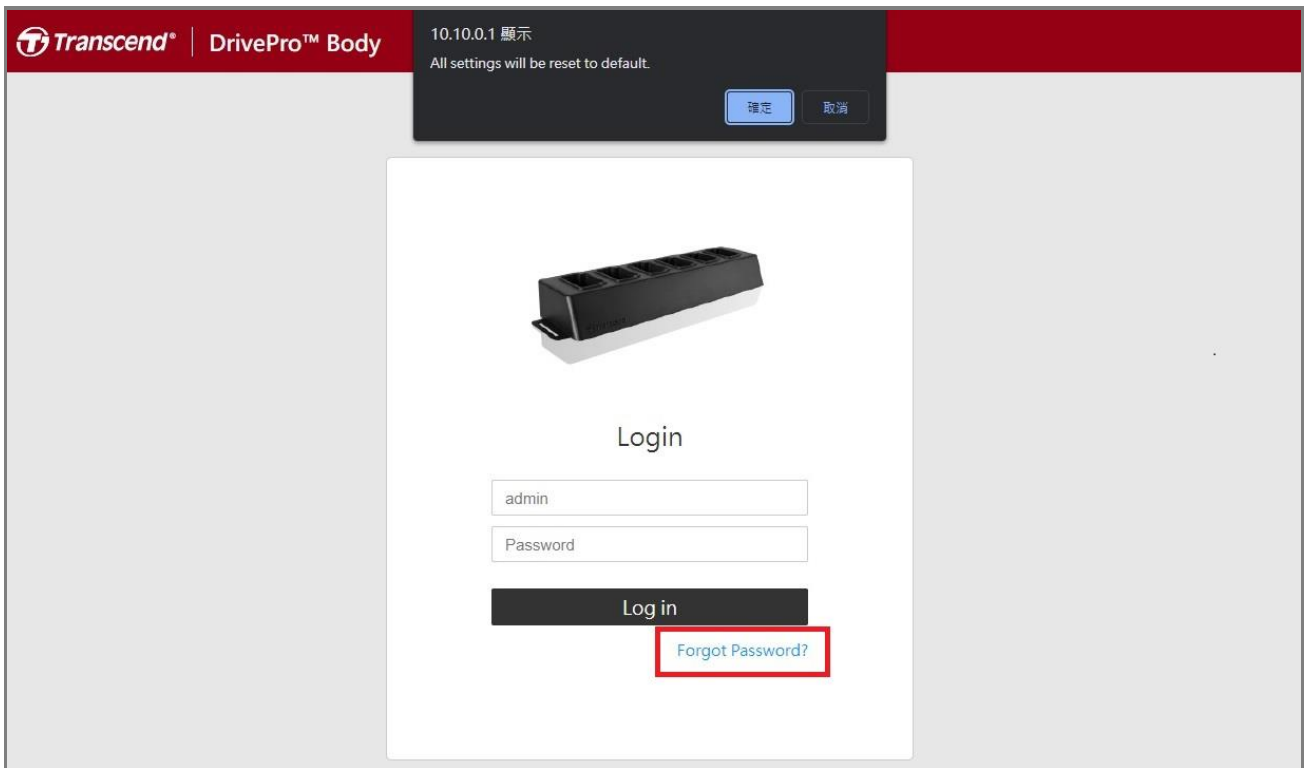

## 2-4 Firmware Update

Refer to the following steps to update the firmware of your DPD6N to the latest version.

1. Open your browser. Link to DPD6N Support & Download page at Transcend’s website: <https://www.transcend-info.com/support/product/body-camera/docking-station-ts-dpd6n>.
2. Download and unzip the **DPD6N Update Tool**, the firmware update file for TS-DPD6N Docking Station.
3. Use one Ethernet cable to connect the LAN port of the DPD6N and the computer’s Internet port.

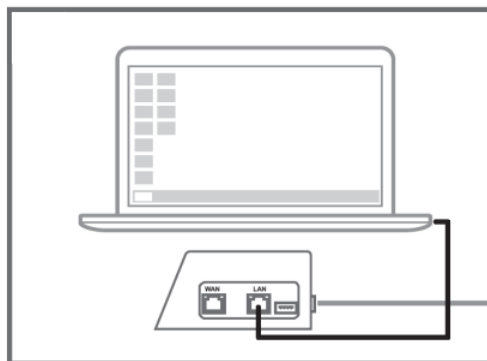

4. Change the computer's IP address to 10.10.0.100.

**NOTE**

If the DPD6N is installed with the version 1.9 or later firmware, the computer will automatically obtain the IP address. This step can be omitted.

5. Double click **DPD6N\_Update\_Tool.exe**

6. Click on **Update** and wait for the update to complete.

**NOTE**

Please do not disconnect the network during the process.

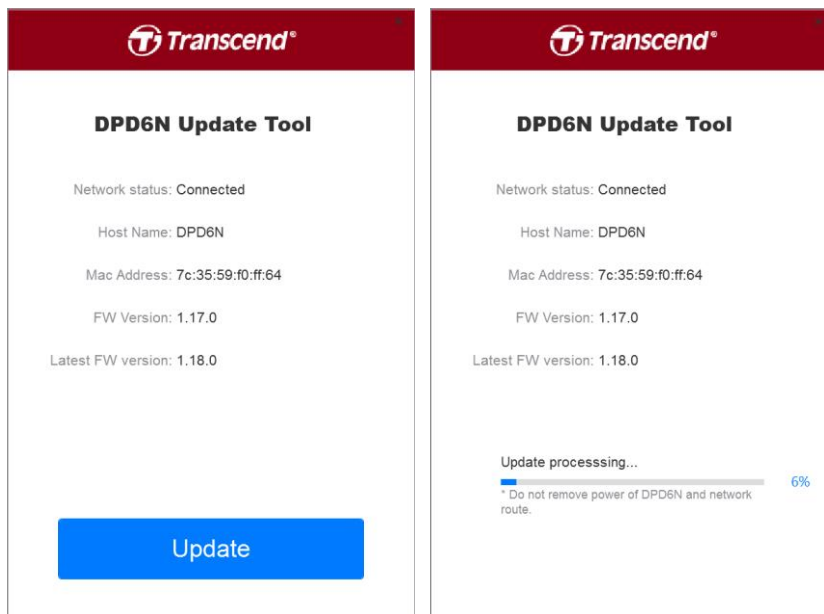

7. If the update is successful, the following image will appear.

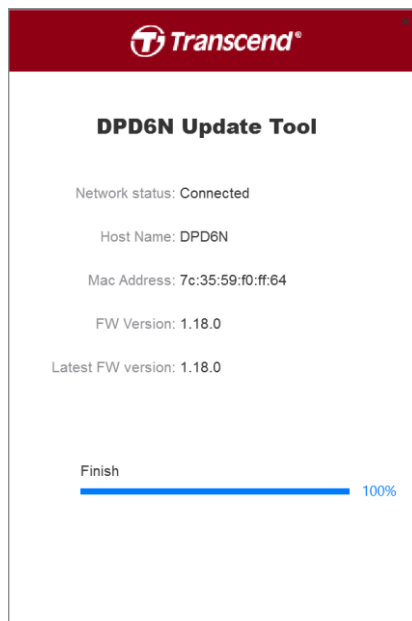

### 3. Specifications



<b>Dimensions</b>	423 mm (L) × 105 mm (W) × 54 mm (H) (16.65" x 4.13" x 2.13")
<b>Weight</b>	980g (34.57 oz)
<b>USB Interface</b>	USB 3.1 Gen 1 (backwards compatible with USB2.0)
<b>Network Port</b>	WAN: 10/100/1000 Mbps Ethernet LAN: 10/100 Mbps Ethernet
<b>Power Supply</b>	12V / 3A
<b>Operating Temperature</b>	0°C (32°F) ~ 40°C (104°F)
<b>Storage Temperature</b>	-20°C (-4°F) ~ 70°C (158°F)
<b>Certification</b>	BSMI, CE, EAC, FCC, KC, RCM, UKCA
<b>Warranty</b>	2-Year Limited Warranty * Please access the Transcend website for more information about the Transcend Warranty Policy.
<b>System Requirements</b>	Desktop or notebook computer with an Internet port, and one of the following operating systems: <ul style="list-style-type: none"> <li>● Microsoft Windows 7</li> <li>● Microsoft Windows 8</li> <li>● Microsoft Windows 8.1</li> <li>● Microsoft Windows 10</li> </ul>

\* Environmental conditions may increase or decrease specifications

## **4. Frequently Asked Questions**

If you have any question or if a problem occurs to your Docking Station, please first check the instructions listed below before sending your DPD6N for repair. If you cannot find any ideal solution to your question below, please consult your dealer, service center, or local Transcend branch office for further help. You can also visit the Transcend website (<https://www.transcend-info.com/>) for more FAQs and Technical Support services ([https://www.transcend-info.com/Support/contact\\_form](https://www.transcend-info.com/Support/contact_form)).

### **■ What are the transfer speeds of DPD6N?**

DPD6N transfers data through either network connection or USB connection. Their speeds are as follows:

1. The transfer speed of DPD6N via network connection is about 16MB/s.
2. The transfer speed of DPD6N via a USB port (with USB3.0) is about 10MB/s.

\* Please note that the USB port can only be connected with an external device, and not to personal PCs.

\* The transfer speeds will be subject to the platforms and network conditions (e.g. whether it's USB3.0 or USB2.0, or the bandwidth of the Wi-Fi router),

### **■ How long does it take for a completely depleted DrivePro Body 30/60/70 battery to be recharged?**

It takes about 6 hours for a completely depleted DrivePro Body 30/60/70 battery to be fully charged with DPD6N.

## **5. Recycling and Environmental Protection**

For more information on **recycling the product (WEEE)** and **battery disposal**, please refer to the following link: <https://www.transcend-info.com/about/green>.

## **6. Warranty Policy**

Please find the warranty period of this product on its package. For details of **Warranty Terms and Conditions** and **Warranty Periods**, please refer to the link below: <https://www.transcend-info.com/warranty>.

## **7. GNU General Public License (GPL) Disclosure**

Please visit <https://www.transcend-info.com/Legal/?no=10> to view more information on open-source licensing.

## **8. End-User License Agreement (EULA)**

For details of software license terms, please refer to the following link: <https://www.transcend-info.com/legal/gpl-disclosure-eula>.



## **9. Federal Communications Commission (FCC) Statement**

This device complies with Part 15 FCC Rules. Operation is subject to the following two conditions: (1) This device may not cause harmful interference. (2) This device must accept any interference received including interference that may cause undesired operation.

This Equipment has been tested and found to comply with the limits for a Class B digital device, pursuant to Part 15 of the FCC rules. These limits are designed to provide reasonable protection against harmful interference in a residential installation. This equipment generates, uses and can radiate radio frequency energy and, if not installed and used in accordance with the instructions, may cause harmful interference to radio communications. However, there is no guarantee that interference will not occur in a particular installation. If this equipment does cause harmful interference to radio or television reception, which can be determined by turning the equipment off and on, the user is encouraged to try to correct the interference by one or more of the following measures:

- Reorient or relocate the receiving antenna.
- Increase the separation between the equipment and receiver.
- Connect the equipment into an outlet on a circuit different from that to which the receiver is connected.
- Consult the dealer or an experienced radio/TV technician for help.

## **10. EU Compliance Statement**

Transcend Information hereby declares that all CE marked Transcend products incorporating radio equipment functionality are in compliance with Directive 2014/53/EU.

The full text of the EU declaration of conformity is available at the following internet address:

[https://www.transcend-info.com/eu\\_compliance](https://www.transcend-info.com/eu_compliance)

### **Dashcam / Body Camera series**

---

<b>Frequency:</b>	<b>Maximum transmit power:</b>
2400 MHz to 2483.5 MHz	< 100 mW

---



## **11. Eurasian Conformity Mark (EAC)**

