

Embedded Solutions



microSD Cards

microSDHC220I

Transcend's SLC Mode technology is a cost-effective solution that offers performance close to that of SLC NAND flash at a more affordable price. These industrial-grade microSD cards combine the advantages of high-performance, exceptional endurance, and wide temperature tolerance (-40°C to 85°C) at affordable prices, making them ideal for write-intensive applications such as medical devices, surveillance systems, and POS terminals.

Hardware Features

- Compliant with RoHS 2.0 standards
- Promised operational reliability in a wide temperature range (from -40°C to 85°C)
- Compliant with SD specification 3.01
- Electrostatic protection (ESD IEC 61000-4-2)
- Supports Transcend Scope Pro software

Firmware Features

- Supports S.M.A.R.T. function to conduct health monitoring, analysis, and reporting for storage devices
- Built-in ECC (Error Correction Code) functionality
- Wear-Leveling
- Early Move

*Scope Pro is only available when used with the [RDF5](#) card reader.

Ordering Information

2GB	TS2GUSD220I
4GB	TS4GUSD220I
8GB	TS8GUSD220I
16GB	TS16GUSD220I

Specifications

Appearance	Dimensions	11 mm x 15 mm x 1 mm (0.43" x 0.59" x 0.04")
	Form Factor	microSD flash card
Storage	Flash Type	MLC NAND flash (SLC mode)
	Capacity	2 GB / 4 GB / 8 GB / 16 GB
Operating Environment	Operating Voltage	2.7V ~ 3.6V
	Drop Test	1.5m free fall
	Operating Temperature	Wide Temp. -40°C (-40°F) ~ 85°C (185°F)
	Storage Temperature	-40°C (-40°F) ~ 85°C (185°F)
	Humidity	0% ~ 95%
	Shock	Acceleration: 490 m/s ² (standard holding time: 11 ms, semi-sine wave, velocity change: 3.44 m/s)
	Vibration (Operating)	20 G (peak-to-peak), 20 Hz ~ 2,000 Hz (frequency)
Power	Power Consumption (Max.)	0.72 watt(s)
Performance	Read Speed (Max.)	up to 80 MB/s
	Write Speed (Max.)	up to 45 MB/s
	Terabytes Written (TBW)	up to 300 TBW
Warranty	Certificate	CE / FCC
	Warranty	Three-year Limited Warranty

Mechanical Dimensions

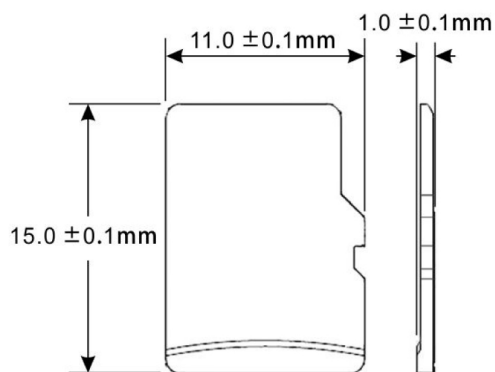

Product specifications are subject to change without notice. Pictures shown may differ from actual products. Total accessible capacity varies depending on operating environment. Due to the complexity and variety of industrial applications, Transcend cannot guarantee 100% compatibility with all platforms and under all scenarios. For special applications and environments, it is strongly suggested that you contact Transcend beforehand for clarification.